



GAMMA PRODOTTI DN 100+

STANDARD O PERSONALIZZABILI



www.cipriani-phe.com

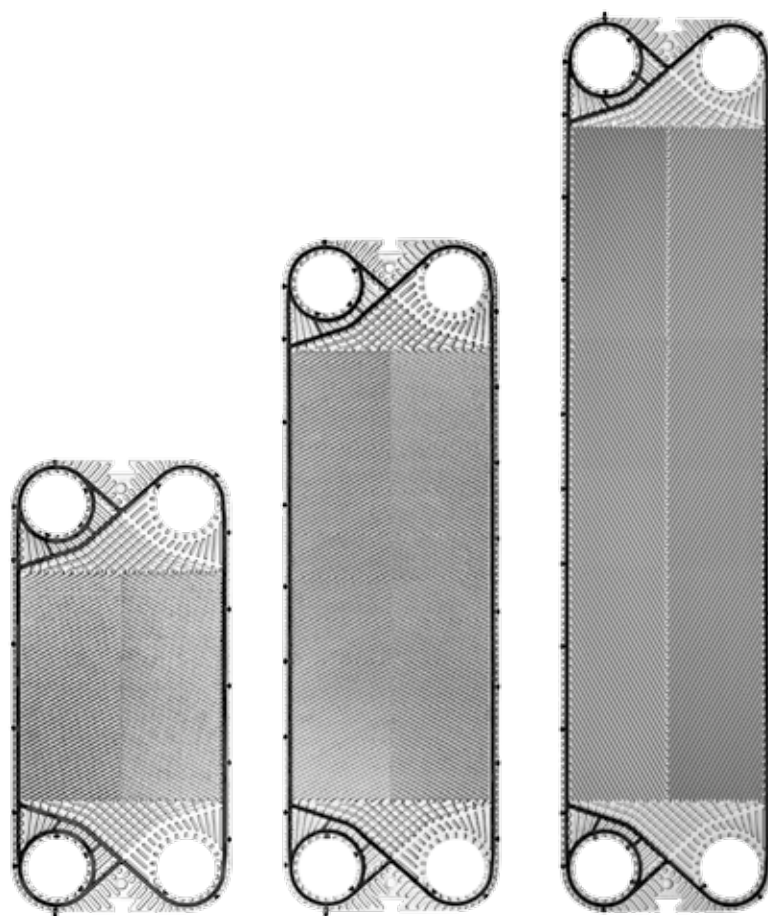

Gamma Prodotti	P300+			P450+			P700+		
Area di scambio [m ²]	0,268			0,482			0,697		
Larghezza [mm]	425			425			425		
Altezza [mm]	877			1322			1767		
Diametro attacchi	DN100 4"			DN100 4"			DN100 4"		
Capacità canale [l]	0,766			1,217			1,669		
Quota di serraggio [mm]	3,1			3,1			3,1		
Peso piastra (con guarnizione) [Kg]	1,42			2,21			3,02		
Angolo di corrugazione	A/B			A/B			A/B		
Portata max d'acqua [m ³ /h]	240			240			240		
PS=> Pressione max di esercizio [bar]	10	16	25	10	16	25	10	16	

Ex art. 3.3 D.Lgs. 93 del 25/02/2000 in applicazione Direttiva 97/23.
I valori di pressione indicati si riferiscono a piastre AISI 316L.

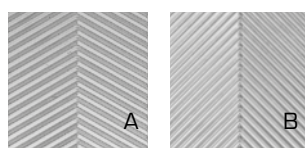

Piastre disponibili in due lunghezze termiche (A/B)

DN32

DN50

DN65

DN100

DN150

DN200

Dimensioni telai

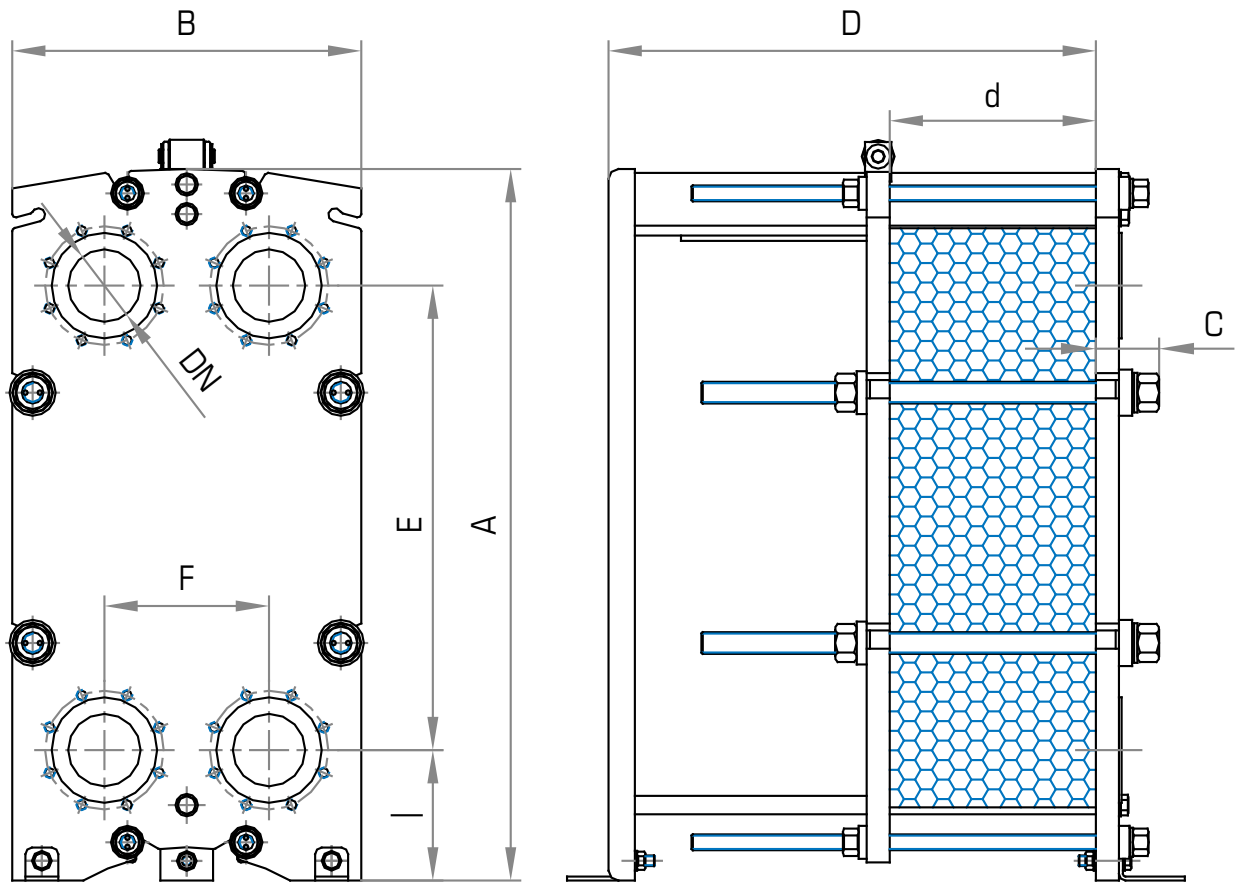

	S300+				S450+				S700			
A	1080				1525				1970			
B	530				530				530			
E	705				1150				1595			
F	250				250				250			
I	198				198				198			
Np max	101	201	301	401	101	201	301	401	101	201	301	401
D max	740	1240	1740	2240	750	1250	1750	2250	750	1250	1750	2250
d (A-A)	3,1 x Np				3,1 x Np				3,1 x Np			
DN	DN100 4"				DN100 4"				DN100 4"			
A-A B-B C-C E-E U-U V-V	PS10	PS16	PS25		PS10	PS16	PS25		PS10	PS16		
C	96	101	111		96	101	111		96	101		
A-A B-B C-C E-E		4				4				4		
U-U V-V		0				0				0		

Tutte le dimensioni sono in mm - Np = numero di piastre

Disegni degli attacchi

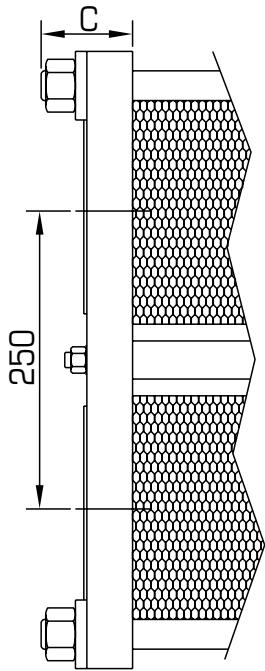

A-A

A flangiare EN 1092-1 con manichette in gomma

B-B

A flangiare EN 1092-1 con manichette AISI 316

U-U

A flangiare EN 1092-1 senza manichette.

C-C

A flangiare ANSI (fil. metrica) con manichette in gomma.

E-E

A flangiare ANSI (fil. metrica) con manichette AISI 316.

V-V

A flangiare ANSI (fil. metrica) senza manichette.

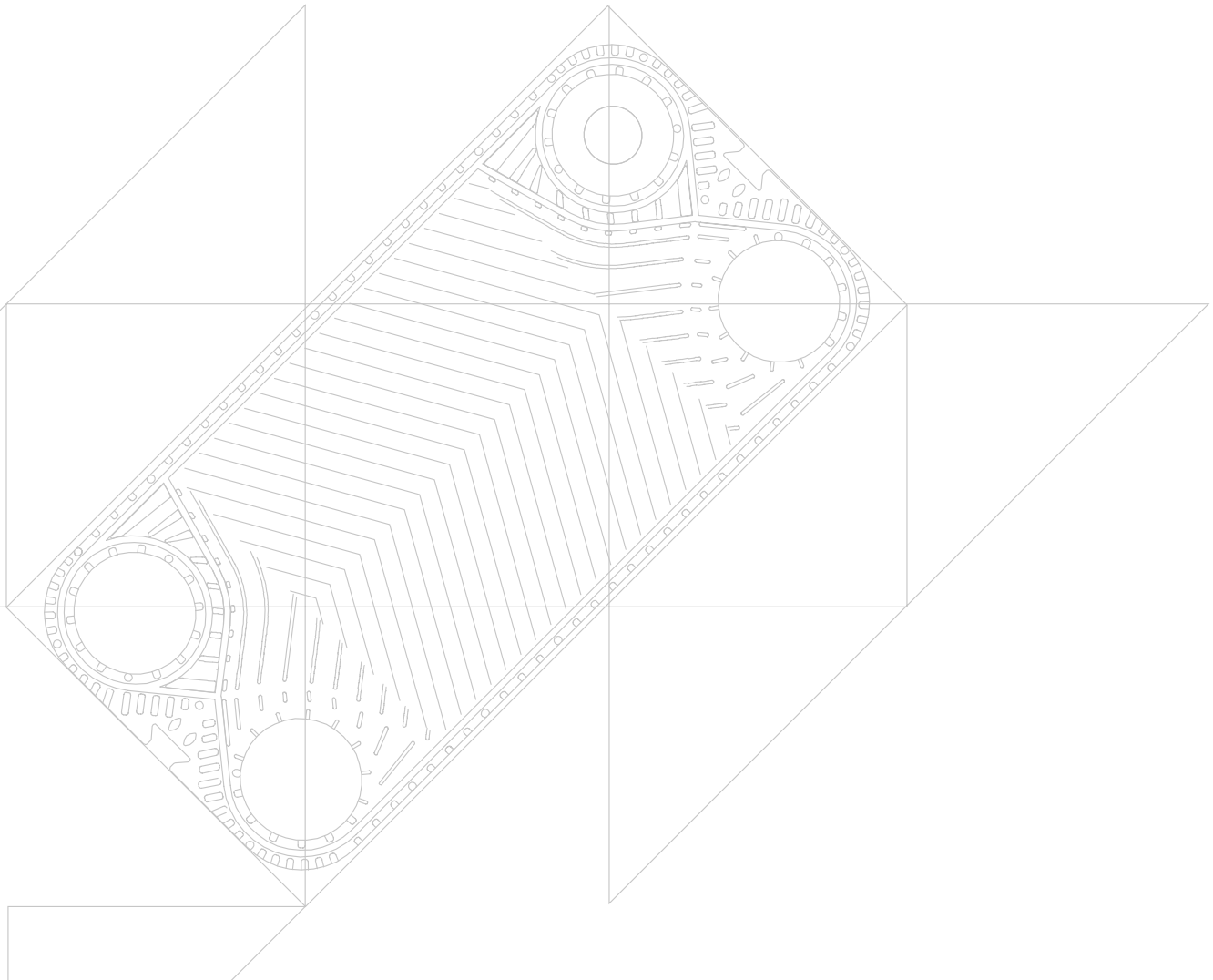

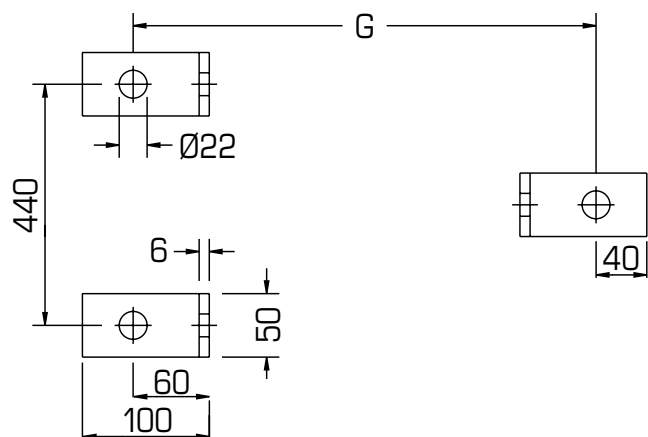

GxH	PS10	PS16	PS25
S300+			
Max 101p	858	863	873
Max 201p	1358	1363	1373
Max 301p	1858	1863	1873
Max 401p	2358	2363	2373
GxH	PS10	PS16	PS25
S450+ / S700+			
Max 101p	861	866	876
Max 201p	1361	1366	1376
Max 301p	1861	1866	1876
Max 401p	2361	2366	2376

Materiali

		S300+	S450+	S700+
Piastre	AISI 304	●	●	●
	AISI 316L	●	●	●
	254 SMO	●	●	●
	Titanio	●	●	●
Guarnizioni	NBR	●	●	●
	EPDM Prx.	●	●	●
	FPM	●	●	●
	HNBR	●	●	●
Telai	Acciaio Carbonio	●	●	●
	AISI 304, rivestito	●	●	●
Attacchi	A-A B-B C-C E-E U-U V-V	●	●	●

Materiali guarnizioni e temperature massime

NBR	-20 °C	110 °C
EPDM Prx.	-20 °C	160 °C
FPM	-20 °C	200 °C
HNBR	-20 °C	160 °C

Le temperature devono essere considerate non applicabili in tutte le condizioni di lavoro.

Esplso componenti Modelli S300+, S450+, S700+

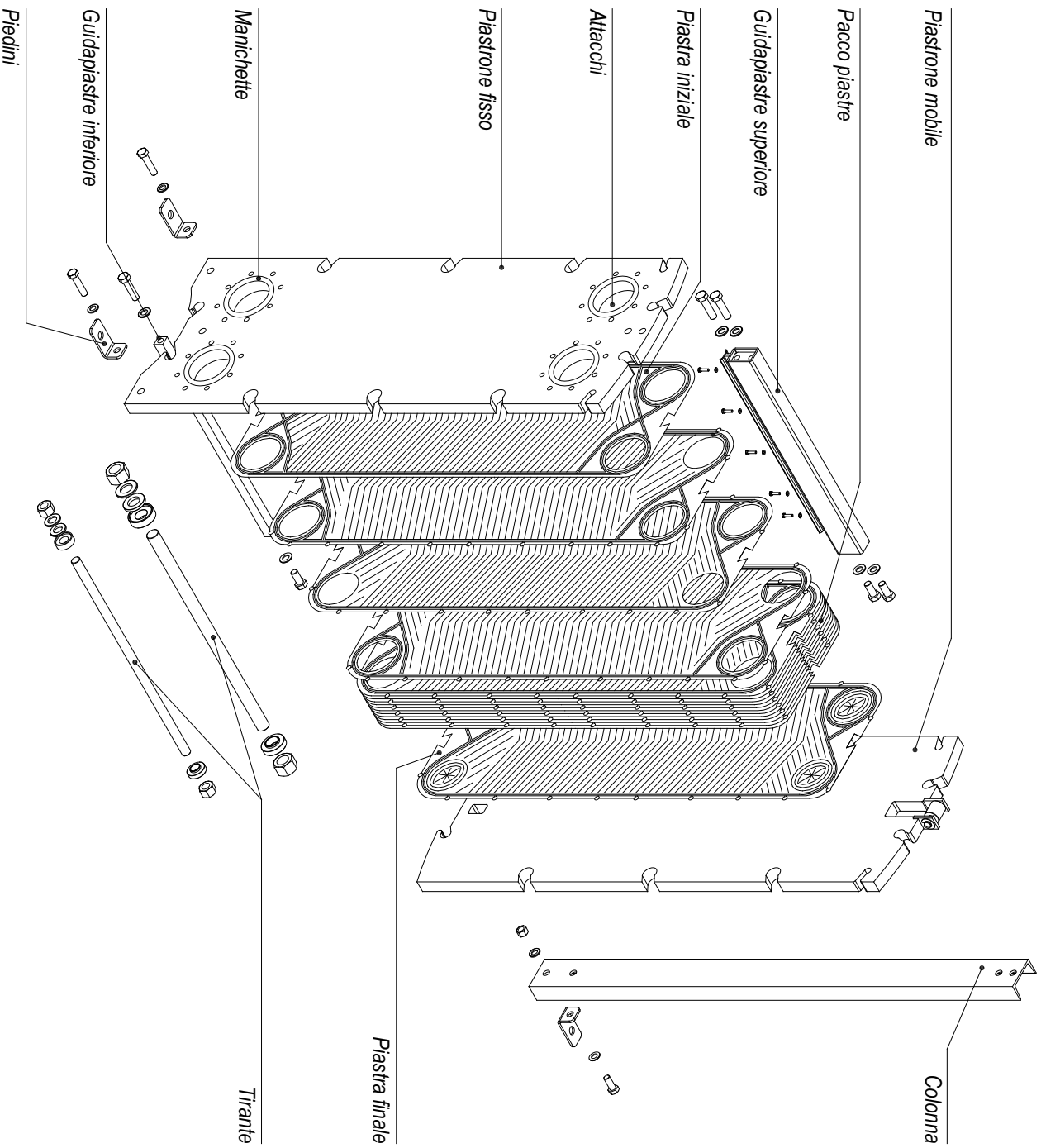

CERTIFICATIONS APPROVALS



CE

- ISO 9001
Quality Management
- PED 2014/68/EU
Pressure Equipment Directive
Module B, D1 & D (Up to Risk Cat. IV)



- ACS
Attestation de Conformité Sanitaire



- WRAS
EPDM/prx gasket compound approved



- OHSAS 18001
Occupational Health and Safety



- ISO 14001
Environmental Management

MADE IN ITALY

